



Glowrail

spec sheet

Key features

Tailored: Fully tailorable in curved/straight/angular and helical sections with even light diffusion throughout.

LED: Wide range of light outputs, colour temperatures and colours.

Control: Switched, 0-10/1-10v, DALI, DMX and SPI dimming protocols.

Material: Stainless Steel, Anodised Aluminium and Wood with various cladding options.

Aesthetic: Harmonised joins and mechanical fixing for discreet architectural integration.

Longevity: 50,000+ LED lifetime expectancy.

Sustainability: Maintainable LED modules.

Application: Interior and exterior pathway and stair lighting.

Glowrail by The Light Lab



Glowrail

the light lab
bright ideas

Product Details Glowrail



Specification

| Output | SO | HO |
|------------------------------|-----------------------------------------------------------------------------------------------------------------------------|--------------|
| Power Consumption | 9.6 W/m | 14.4 W/m |
| Efficacy | 54 Lm/W | 73 Lm/W |
| Voltage | 48VDC | 48VDC |
| IP Rating | IP40 or IP65 | IP40 or IP65 |
| LED Colour ¹ | 2.7K/3.0K/4.0K/5.0K, RGBW or WWCW (White Mix 2.7K - 6.5K) | |
| Diameter ² | 42mm or 48.3mm | |
| Mount Type | Post (PT), Bracket (BK), Balustrade (BD) | |
| Handrail Finish ³ | Brushed S/Steel (BR) Polished S/Steel (PO) Powder-coated (PC) / Aluminium (AL) Timber (TI) / Leather Cladding (LC) | |
| Control | 0-10V/1-10V/DMX/DALI/SPI | |

Notes

- 1 Other colours available on request.
- 2 For integration into a bespoke profile, please contact the team.
- 3 Stainless Steel 304 or 316. Other finishes available on request.

Order code

GR-Diameter-IP Rating-LED Colour-Mount Type-Finish-Length-Dimming

Example: Code: GR42-SO-IP40-SS-3.0K-BK-BR-6000-DALI

Description: Glowrail42, standard output, IP40, 48VDC constant voltage, LED with 3000K colour temperature. bracket mounted in brushed stainless steel. Length=6000mm. DALI Dimmable



X Section

42.4mm Ø

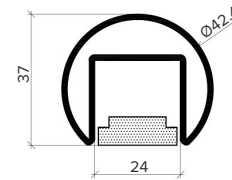

48.3mm Ø

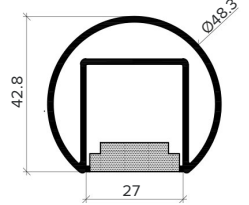

48.3mm Ø generic

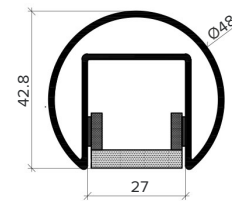

48.3mm Ø timber

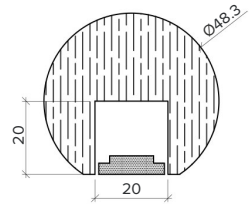

Typical Bracket Coverplate

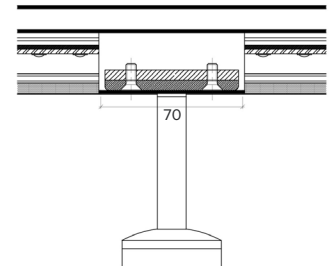

Photometric Info

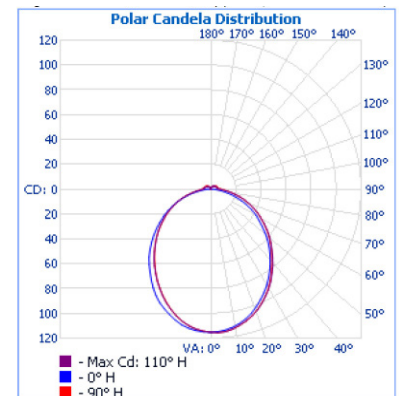

Photometric data from a GL25-HO fitting LTD & IES files available on request



The Light Lab
22 Holywell Row
London EC2A 4JB
+44 (0) 207 278 2678
@thelightlabltd
www.thelightlab.com

the light lab
bright ideas

Typical Fixing Details Glowrail



Surface Mounted Bracket

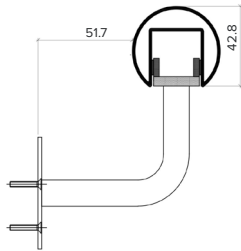

SMB-SS-304-316
Aluminium Anodised on Request

Wall Bracket

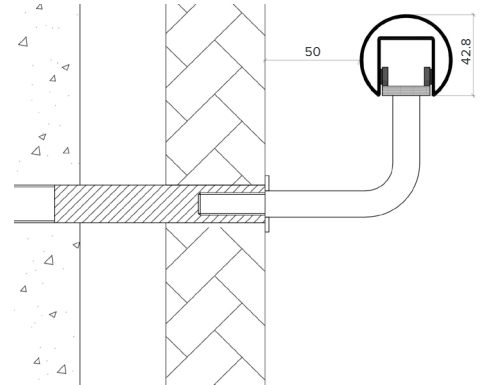

WB-SS-304-316
Aluminium Anodised on Request

Panel Mounted Bracket

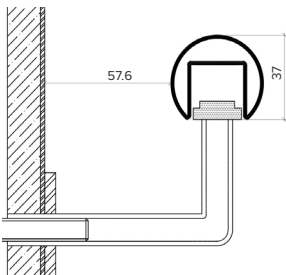

SMB-SS-304-316
Aluminium Anodised on Request

Standard Post Bracket

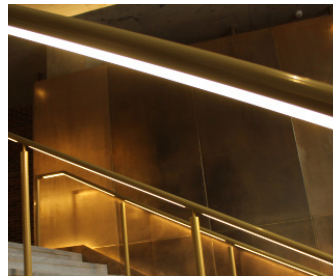
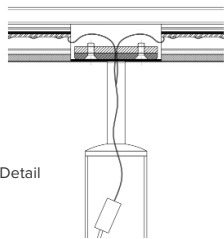

Top Detail

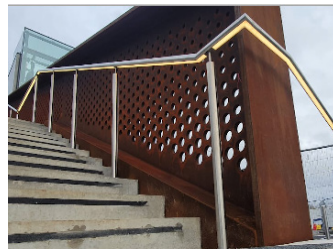
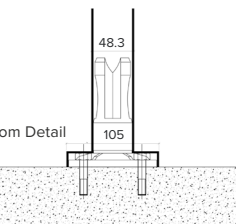

Bottom Detail

PB-SS-304-316
Aluminium Anodised on Request

Split Post Bracket

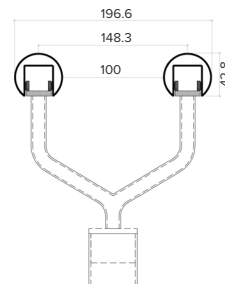

Asymetric Post Bracket

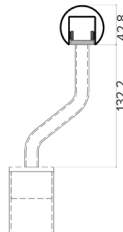

SPB-SS-304-316
Aluminium Anodised on Request

Project Images



Hiscox, York

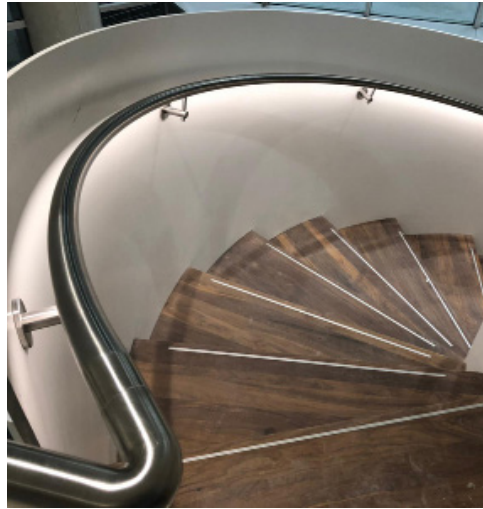

Purdy's Wharf, Canada



St Paul's Girls School, London



University of Edinburgh



The Ivy, Canada Square Park

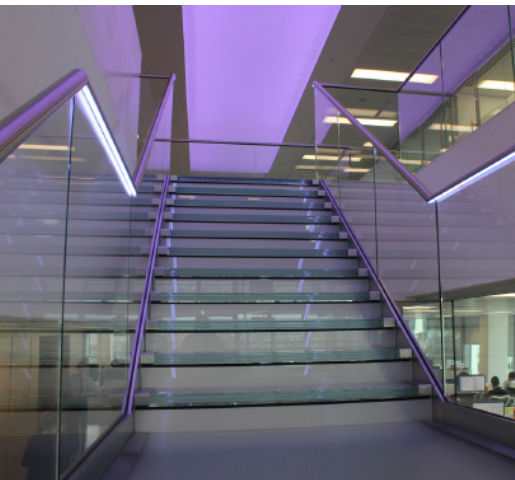

Liberty Specialist Markets

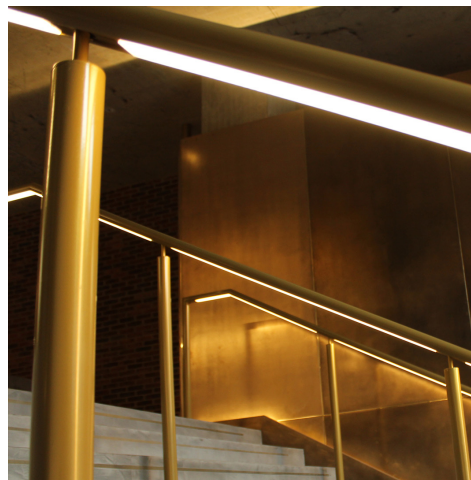

Jamestown Road

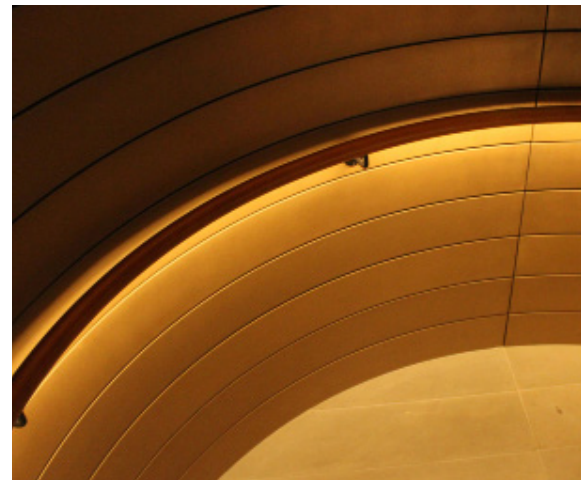

Boulevard Theatre